

Anodi per motori SUZUKI

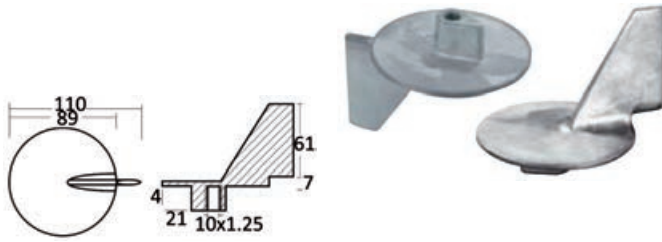

Pinna per motori Suzuki



Per motori Suzuki senza raffreddamento 150/175/200/225 HP 2 tempi + 60/70 HP 4 tempi

Codice	Ø mm	Riferimento originale
43.272.80	88	55120-87801 / 5512587D00

Pinna per 60/140 HP 2/4 tempi

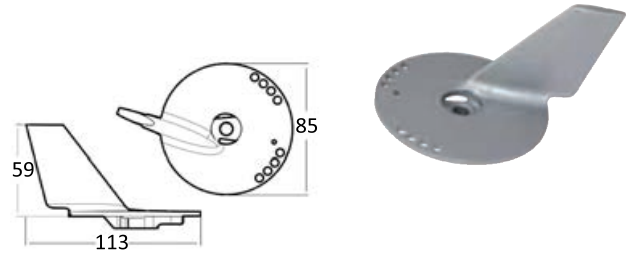

Codice	Ø mm	Riferimento originale
43.272.85	84	5032929

Pinna per 55/65/75/85 HP + 40/70 4 tempi

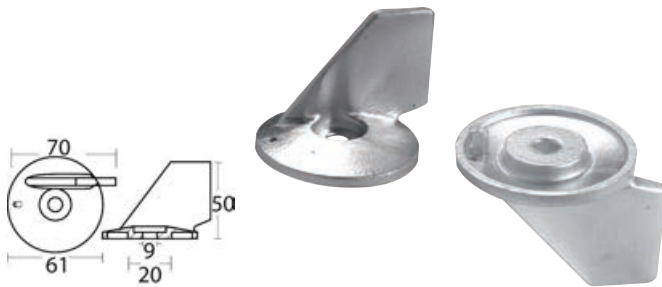

Zinco	Alluminio	Magnesio	Ø mm	Riferimento originale
43.272.86	43.272.82	43.272.83	60	55125-87E01

Pinna per motori Suzuki DF60/140 con fori.

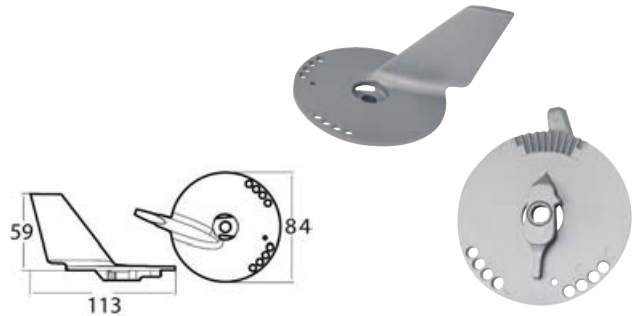

Zinco	Alluminio	Magnesio	Riferimento originale
43.272.87	43.272.88	43.272.89	55125-90J01

Pinna 20/35 HP 2/3 cilindri, 2/4 tempi

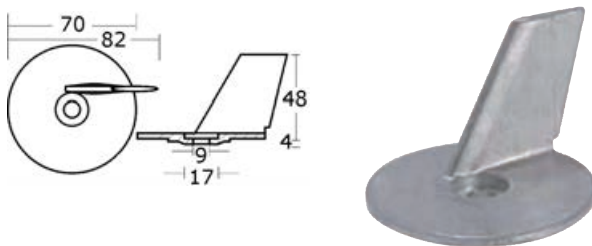

Codice	Ø mm	Riferimento originale
43.272.00	70	55125-96310

Pinna per 25/50 HP

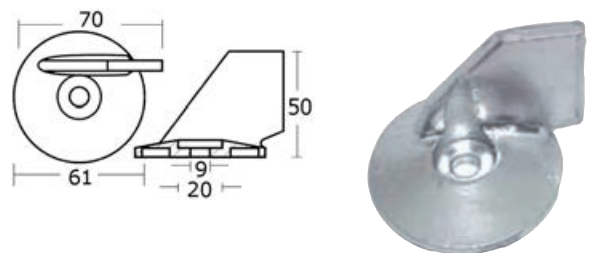

Codice	Ø mm	Riferimento originale
43.272.70	60	55125-96301

Piastrina 40/115 2 tempi - 25/300 HP 4 tempi

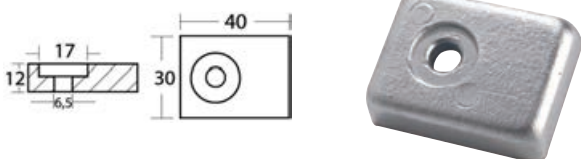

Zinco	Alluminio	Magnesio	Riferimento originale
43.903.20	43.903.21	43.903.22	55320-95311

Piastrina in alluminio per morsetteria 55/75/85/90/150/200/225 HP



Codice	Riferimento originale
43.272.31	55320-95311